

## Surface-mounting, 2.6-GHz-Band, Miniature, SPDT, High-frequency Relay

- ROHS compliant.
- Superior high-frequency characteristics, such as an isolation of 30 dB min., insertion loss of 0.5 dB max., and V.SWR of 1.5 max. at 2.6 GHz.
- Surface-mounting terminals and superior high frequency characteristics combined using semi triplate strip transmission lines.
- Miniature dimensions of 20 x 8.6 x 8.9 mm (L x W x H).
- Choose from a lineup that includes single-winding latching models (200 mW), double-winding latching models (360 mW), and models with a reverse contact arrangement.
- Series includes models with an E-shape terminal structure (same as existing models), and models with a Y-shape terminal structure, allowing greater freedom with PCB design.
- Models with 75-Ω impedance and models with 50-Ω impedance are available.

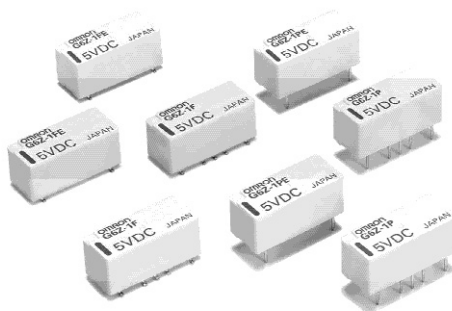

## Ordering Information

### Model Number Legend

**G6Z-**□-□□□-□□  
 1 2 3 4 5 6

#### 1. Relay Function

None: Single-side stable  
 U: Single-winding latching  
 K: Double-winding latching

#### 2. Contact Form

1: SPDT

#### 3. Terminal Shape

F: Surface-mounting terminals  
 P: PCB terminals

#### 4. Terminal Structure

None: Y-shape terminal structure  
 E: E-shape terminal structure

#### 5. Characteristic Impedance

None: 75 Ω  
 A: 50 Ω

#### 6. Contact Arrangement

None: Standard contact arrangement  
 R: Reverse contact arrangement

## ■ List of Models

### Standard Models with PCB Terminals

Classification	Structure	Contact form	Terminal arrangement	Characteristic impedance	Rated coil voltage	Model
Single-side stable	Plastic sealed	SPDT	E-shape	75 Ω	3, 4.5, 5, 9, 12, and 24 VDC	G6Z-1PE
				50 Ω	3, 4.5, 5, 9, 12, and 24 VDC	G6Z-1PE-A
			Y-shape	75 Ω	3, 4.5, 5, 9, 12, and 24 VDC	G6Z-1P
				50 Ω	3, 4.5, 5, 9, 12, and 24 VDC	G6Z-1P-A
Single-winding latching			E-shape	75 Ω	3, 4.5, 5, 9, 12, and 24 VDC	G6ZU-1PE
				50 Ω	3, 4.5, 5, 9, 12, and 24 VDC	G6ZU-1PE-A
			Y-shape	75 Ω	3, 4.5, 5, 9, 12, and 24 VDC	G6ZU-1P
				50 Ω	3, 4.5, 5, 9, 12, and 24 VDC	G6ZU-1P-A
Double-winding latching	E-shape	75 Ω	3, 4.5, 5, 9, 12, and 24 VDC	G6ZK-1PE		
		50 Ω	3, 4.5, 5, 9, 12, and 24 VDC	G6ZK-1PE-A		
	Y-shape	75 Ω	3, 4.5, 5, 9, 12, and 24 VDC	G6ZK-1P		
		50 Ω	3, 4.5, 5, 9, 12, and 24 VDC	G6ZK-1P-A		

### Standard Models with Surface-mounting Terminals

Classification	Structure	Contact form	Terminal arrangement	Characteristic impedance	Rated coil voltage	Model
Single-side stable	Plastic sealed	SPDT	E-shape	75 Ω	3, 4.5, 5, 9, 12, and 24 VDC	G6Z-1FE
				50 Ω	3, 4.5, 5, 9, 12, and 24 VDC	G6Z-1FE-A
			Y-shape	75 Ω	3, 4.5, 5, 9, 12, and 24 VDC	G6Z-1F
				50 Ω	3, 4.5, 5, 9, 12, and 24 VDC	G6Z-1F-A
Single-winding latching			E-shape	75 Ω	3, 4.5, 5, 9, 12, and 24 VDC	G6ZU-1FE
				50 Ω	3, 4.5, 5, 9, 12, and 24 VDC	G6ZU-1FE-A
			Y-shape	75 Ω	3, 4.5, 5, 9, 12, and 24 VDC	G6ZU-1F
				50 Ω	3, 4.5, 5, 9, 12, and 24 VDC	G6ZU-1F-A
Double-winding latching	E-shape	75 Ω	3, 4.5, 5, 9, 12, and 24 VDC	G6ZK-1FE		
		50 Ω	3, 4.5, 5, 9, 12, and 24 VDC	G6ZK-1FE-A		
	Y-shape	75 Ω	3, 4.5, 5, 9, 12, and 24 VDC	G6ZK-1F		
		50 Ω	3, 4.5, 5, 9, 12, and 24 VDC	G6ZK-1F-A		

**Note:** When ordering tape packing (surface-mounting models), add “-TR” to the model number. “-TR” does not appear on the Relay itself.

## Application Examples

These Relays can be used for switching signals in media equipment.

- **Wire communications:**

Cable TV (STB and broadcasting infrastructure), cable modems, and VRS (video response systems)

- **Wireless communications:**

Transceivers, ham radios, car telephones, ETC, ITS, high-level TV, satellite broadcasting, text multiplex broadcasting, pay TV, mobile phone stations, TV broadcasting facilities, and community antenna systems

- **Public equipment:**

TVs, TV games, satellite radio units, car navigation systems

- **Industrial equipment:**

Measuring equipment, test equipment, and multiplex transmission devices

## Specifications

### ■ Contact Ratings

<b>Lead</b>	Resistive load
<b>Rated load</b>	10 mA at 30 VAC; 10 mA at 30 VDC; 10 W at 900 MHz (See note.)
<b>Contact material</b>	Au-clad (Cu alloy)
<b>Rated carry current</b>	0.5 A
<b>Max. switching voltage</b>	30 VDC, 30 VAC
<b>Max. switching current</b>	0.5 A

**Note:** This value is for impedance of 50 Ω or 75 Ω with a V.SWR of 1.2max.

### ■ High-frequency Characteristics

Item		Frequency		900 MHz				2.6 GHz			
				TH		SMD		TH		SMD	
		E-shape	Y-shape	E-shape	Y-shape	E-shape	Y-shape	E-shape	Y-shape		
Isolation	75 Ω	65 dB min.		60 dB min.		35 dB min.	45 dB min.	30 dB min.	40 dB min.		
	50 Ω	60 dB min.									
Insertion loss (not including substrate loss)	75 Ω	0.2 dB max.				0.5 dB max.					
	50 Ω	0.1 dB max.				0.3 dB max.					
V.SWR	75 Ω	1.2 max.				1.5 max.					
	50 Ω	1.1 max.				1.3 max.					
Return loss	75 Ω	20.8 dB max.				14.0 dB max.					
	50 Ω	26.4 dB max.				17.7 dB max.					
Maximum carry power		10 W (See note 2.)									
Maximum switching power		10 W (See note 2.)									

**Note:** 1. The above values are initial values.

2. These values are for an impedance of 50 Ω or 75 Ω with a V.SWR of 1.2 max.

## ■ Coil Ratings

### Single-side Stable Models

G6Z-1P(E), G6Z-1F(E)

<b>Raged voltage</b>	3 VDC	4.5 VDC	5 VDC	9 VDC	12 VDC	24 VDC
<b>Rated current</b>	66.7 mA	44.4 mA	40.0 mA	22.2 mA	16.7 mA	8.3 mA
<b>Coil resistance</b>	45 Ω	101 Ω	125 Ω	405 Ω	720 Ω	2,880 Ω
<b>Must operate voltage</b>	75% max. of rated voltage					
<b>Must release voltage</b>	10% min. of rated voltage					
<b>Maximum voltage</b>	150% of rated voltage					
<b>Power consumption</b>	Approx. 200 mW					

### Single-winding Latching Models

G6ZU-1P(E), G6ZU-1F(E)

<b>Raged voltage</b>	3 VDC	4.5 VDC	5 VDC	9 VDC	12 VDC	24 VDC
<b>Rated current</b>	66.7 mA	44.4 mA	40.0 mA	22.2 mA	16.7 mA	8.3 mA
<b>Coil resistance</b>	45 Ω	101 Ω	125 Ω	405 Ω	720 Ω	2,880 Ω
<b>Must operate voltage</b>	75% max. of rated voltage					
<b>Must release voltage</b>	75% max. of rated voltage					
<b>Maximum voltage</b>	150% of rated voltage					
<b>Power consumption</b>	Approx. 200 mW					

### Double-winding Latching Models

G6ZK-1P(E), G6ZK-1F(E)

<b>Raged voltage</b>	3 VDC	4.5 VDC	5 VDC	9 VDC	12 VDC	24 VDC
<b>Rated current</b>	120 mA	80 mA	72 mA	40 mA	30 mA	15 mA
<b>Coil resistance</b>	25 Ω	56 Ω	69 Ω	225 Ω	400 Ω	1,600 Ω
<b>Must operate voltage</b>	75% max. of rated voltage					
<b>Must release voltage</b>	75% max. of rated voltage					
<b>Maximum voltage</b>	150% of rated voltage					
<b>Power consumption</b>	Approx. 360 mW					

- Note:**
1. The rated current and coil resistance are measured at a coil temperature of 23°C with a tolerance of ±10%.
  2. The operating characteristics are measured at a coil temperature of 23°C.
  3. The maximum voltage is the highest voltage that can be imposed on the Relay coil instantaneously.

# Surface-Mounting High-Frequency Relay – G6Z

## ■ Characteristics

Item	Single-side stable models	Single-winding latching models	Double-winding latching models
	G6Z-1P(E), G6Z-1F(E)	G6ZU-1P(E), G6ZU-1F(E)	G6ZK-1P(E), G6ZK-1F(E)
Contact resistance (See note 2.)	100 mΩ max.		
Operating (set) time (See note 3.)	10 ms max. (approx. 3.5 ms)		10 ms max. (approx. 2.5 ms)
Release (reset) time (See note 3.)	10 ms max. (approx. 2.5 ms)		
Minimum set/reset pulse time	---		12 ms
Insulation resistance (See note 4.)	100 MΩ min. (at 500 VDC)		
Dielectric strength	Coil and contacts	1,000 VAC, 50/60 Hz for 1 min	
	Coil and ground, contacts and ground	500 VAC, 50/60 Hz for 1 min	
	Contacts of same polarity	500 VAC, 50/60 Hz for 1 min	
Vibration resistance	Destruction: 10 to 55 to 10 Hz, 0.75-mm single amplitude (1.5-mm double amplitude) Malfunction: 10 to 55 to 10 Hz, 0.75-mm single amplitude (1.5-mm double amplitude)		
Shock resistance	Destruction: 1,000 m/s <sup>2</sup> Malfunction: 500 m/s <sup>2</sup>		
Endurance	Mechanical: 1,000,000 operations min. (at 36,000 operations/hour) Electrical: 300,000 operations min. (30 VAC, 10 mA/30 VDC, 10 mA), 100,000 operations min. (900 MHz, 10 W) at a switching frequency of 1,800 operations/hour		
Ambient temperature	Operating: -40°C to 70°C (with no icing or condensation)		
Ambient humidity	Operating: 5% to 85%		
Weight	Approx. 2.8 g		

- Note:**
- The above values are initial values.
  - The contact resistance was measured with 10 mA at 1 VDC with a voltage drop method.
  - Values in parentheses are actual values.
  - The insulation resistance was measured with a 500-VDC megohmmeter applied to the same parts as those used for checking the dielectric strength.

## Engineering Data

**Ambient Temperature vs. Maximum Voltage**

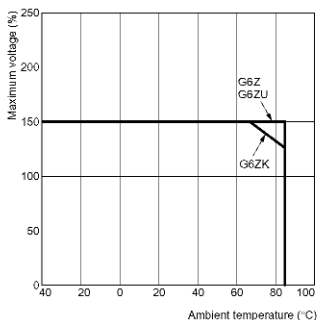

**Ambient Temperature vs. Must Operate or Must Release Voltage**

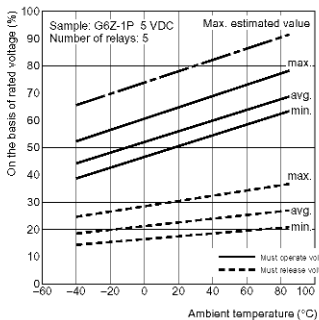

**Shock Malfunction**

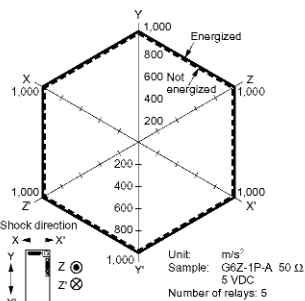

Conditions: Shock is applied in X, Y, and Z directions three times each with and without energizing the Relays to check for contact malfunctions.

# Surface-Mounting High-Frequency Relay – G6Z

## Electrical Endurance (with Must Operate and Must Release Voltage)

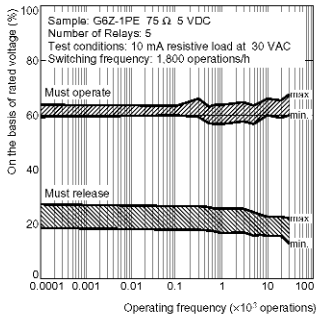

## Electrical Endurance (with Must Operate and Must Release Voltage)

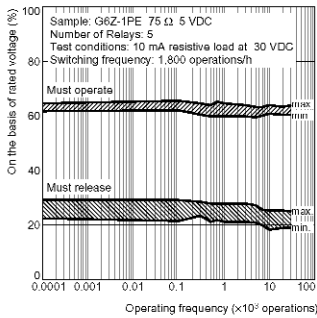

## Electrical Endurance (Contact Resistance)

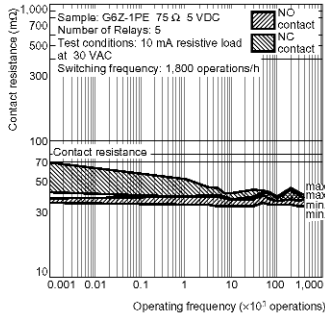

## Electrical Endurance (Contact Resistance)

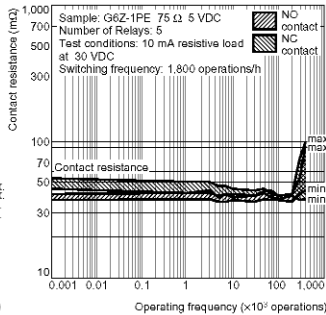

## External Magnetic Interference

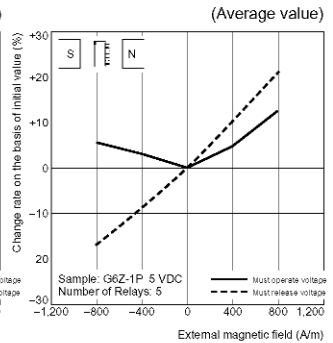
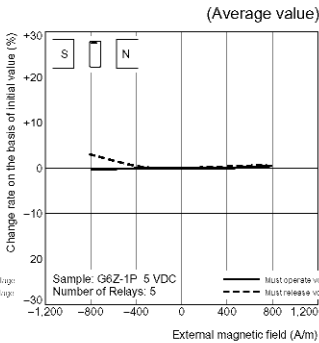
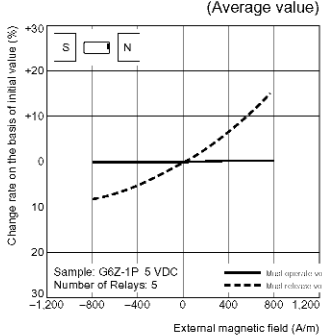

# Surface-Mounting High-Frequency Loss Relay – G6Z

**High-frequency Characteristics at 75 Ω (Isolation)**

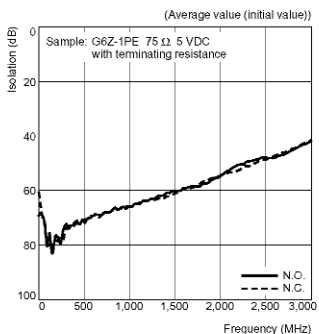

**High-frequency Characteristics at 75 Ω (Insertion Loss)**

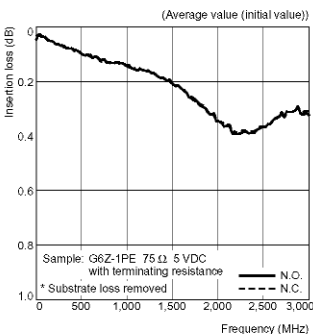

**High-frequency Characteristics at 75 Ω (Return Loss, V.SWR)**

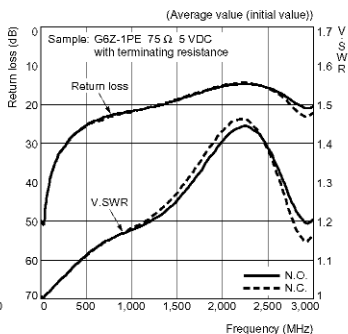

**High-frequency Characteristics at 50 Ω (Isolation)**

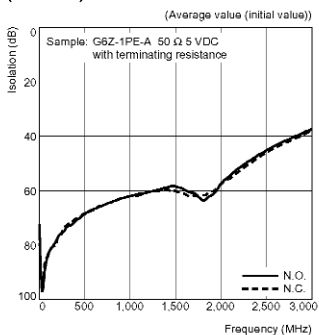

**High-frequency Characteristics at 50 Ω (Insertion Loss)**

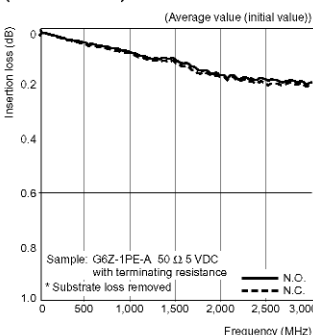

**High-frequency Characteristics at 50 Ω (Return Loss, V.SWR)**

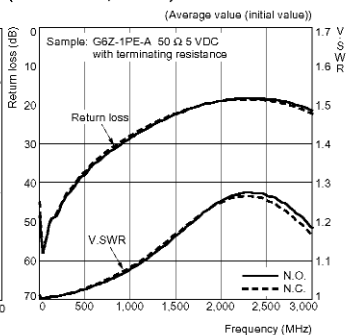

**Must Operate and Must Release Time Distribution (See note.)**

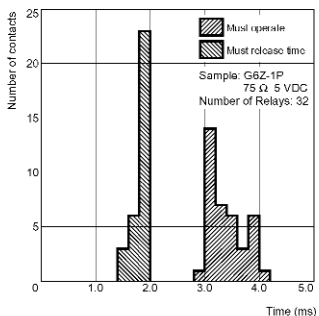

**Must Operate and Must Release Bounce Time Distribution (See note.)**

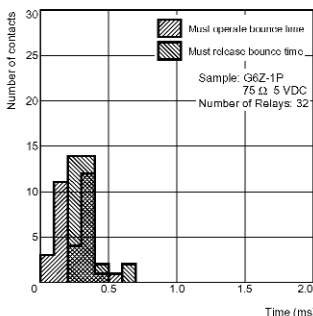

**Note:** The tests were conducted at an ambient temperature of 23°C.

## Dimensions

**Note:** All units are in millimeters unless otherwise indicated.

### ■ Models with PCB Terminals

G6Z-1PE  
G6ZU-1PE  
G6Z-1PE-R

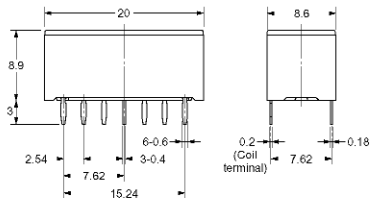
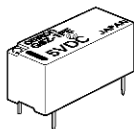

**Note:** Each value has a tolerance of  $\pm 0.3$  mm.

**Mounting Dimensions (Bottom View)**  
Tolerance:  $\pm 0.1$  mm

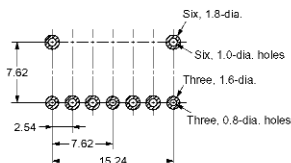

**Terminal Arrangement/Internal Connections (Bottom View)**

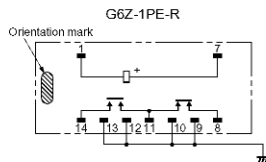
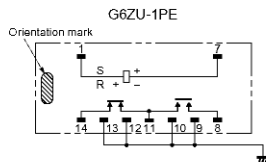
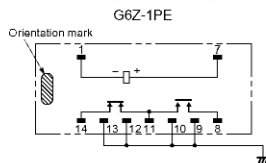

G6Z-1PE-A  
G6ZU-1PE-A

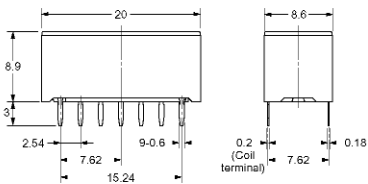
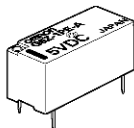

**Note:** Each value has a tolerance of  $\pm 0.3$  mm.

**Mounting Dimensions (Bottom View)**  
Tolerance:  $\pm 0.1$  mm

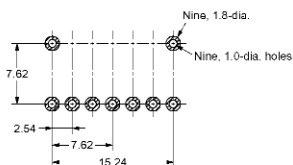

**Terminal Arrangement/Internal Connections (Bottom View)**

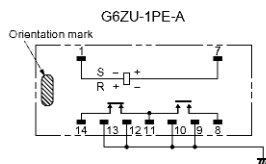
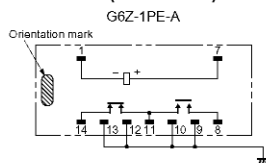



# Surface-Mounting High-Frequency Relay – G6Z

**G6Z-1P**  
**G6ZU-1P**

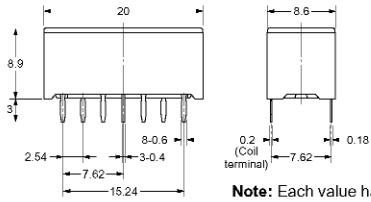
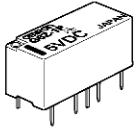

**Note:** Each value has a tolerance of  $\pm 0.3$  mm.

**Mounting Dimensions (Bottom View)**  
Tolerance:  $\pm 0.1$  mm

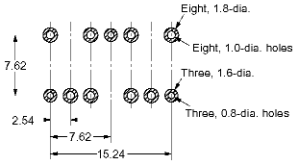

**Terminal Arrangement/Internal Connections (Bottom View)**

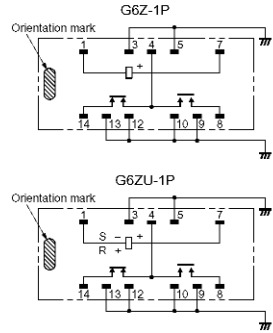

**G6Z-1P-A**  
**G6ZU-1P-A**

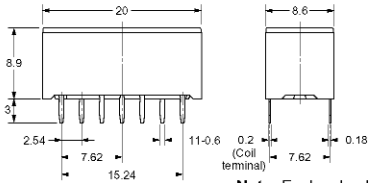
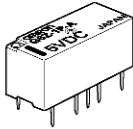

**Note:** Each value has a tolerance of  $\pm 0.3$  mm.

**Mounting Dimensions (Bottom View)**  
Tolerance:  $\pm 0.1$  mm

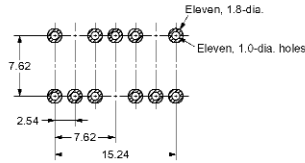

**Terminal Arrangement/Internal Connections (Bottom View)**

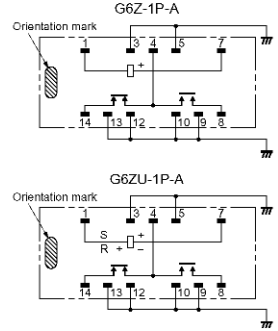

**G6ZK-1PE**

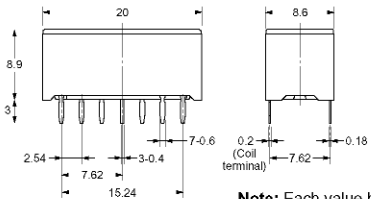
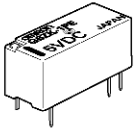

**Note:** Each value has a tolerance of  $\pm 0.3$  mm.

**Mounting Dimensions (Bottom View)**  
Tolerance:  $\pm 0.1$  mm

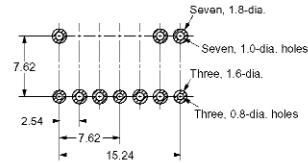

**Terminal Arrangement/Internal Connections (Bottom View)**

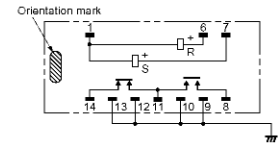

# Surface-Mounting High-Frequency Relay – G6Z

## G6ZK-1PE-A

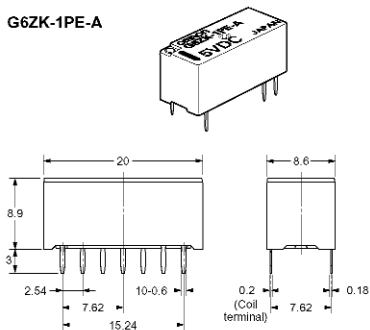

**Note:** Each value has a tolerance of  $\pm 0.3$  mm.

### Mounting Dimensions (Bottom View)

Tolerance:  $\pm 0.1$  mm

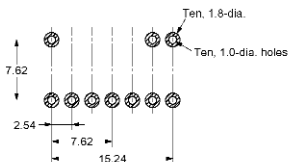

### Terminal Arrangement/Internal Connections (Bottom View)

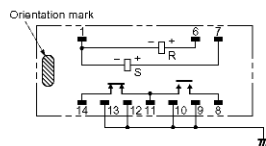

## G6ZK-1P

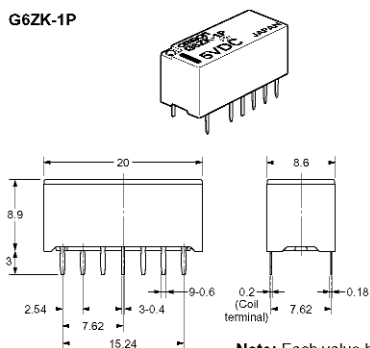

**Note:** Each value has a tolerance of  $\pm 0.3$  mm.

### Mounting Dimensions (Bottom View)

Tolerance:  $\pm 0.1$  mm

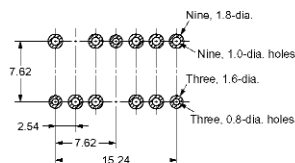

### Terminal Arrangement/Internal Connections (Bottom View)

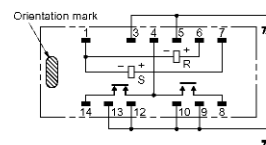

## G6ZK-1P-A

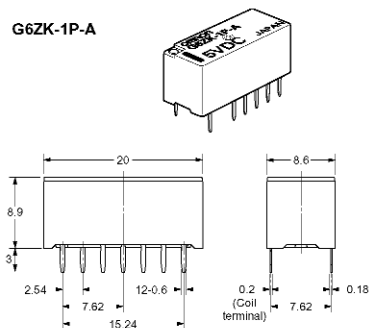

**Note:** Each value has a tolerance of  $\pm 0.3$  mm.

### Mounting Dimensions (Bottom View)

Tolerance:  $\pm 0.1$  mm

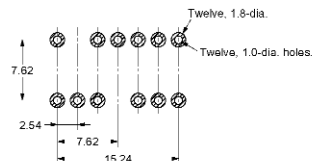

### Terminal Arrangement/Internal Connections (Bottom View)

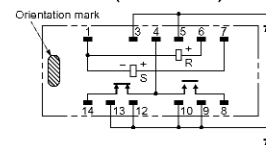

## ■ Models with Surface-mounting Terminals

G6Z-1FE  
G6ZU-1FE

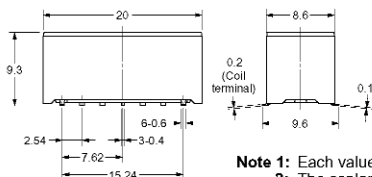
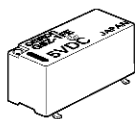

**Note 1:** Each value has a tolerance of  $\pm 0.3$  mm.  
**Note 2:** The coplanarity of the terminals is 0.1 mm max.

**Mounting Dimensions (Top View)**  
Tolerance:  $\pm 0.1$  mm

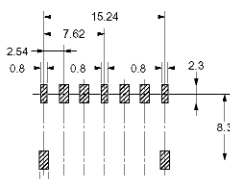

**Terminal Arrangement/Internal Connections (Top View)**

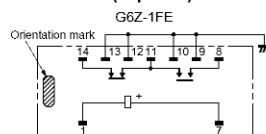

G6Z-1FE-A  
G6ZU-1FE-A

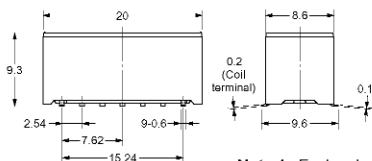
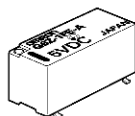

**Note 1:** Each value has a tolerance of  $\pm 0.3$  mm.  
**Note 2:** The coplanarity of the terminals is 0.1 mm max.

**Mounting Dimensions (Top View)**  
Tolerance:  $\pm 0.1$  mm

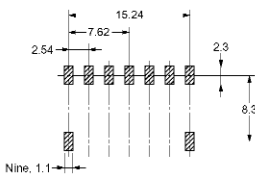

**Terminal Arrangement/Internal Connections (Top View)**

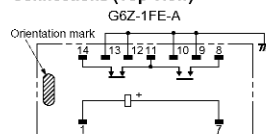

G6Z-1F  
G6ZU-1F

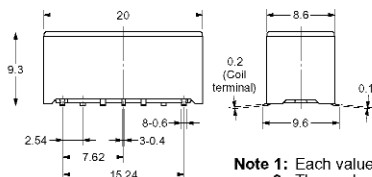
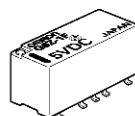

**Note 1:** Each value has a tolerance of  $\pm 0.3$  mm.  
**Note 2:** The coplanarity of the terminals is 0.1 mm max.

**Mounting Dimensions (Top View)**  
Tolerance:  $\pm 0.1$  mm

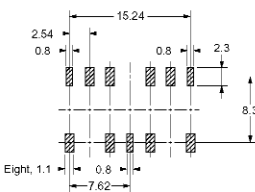

**Terminal Arrangement/Internal Connections (Top View)**

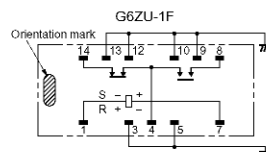
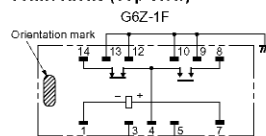

# Surface-Mounting High-Frequency Relay – G6Z

G6Z-1F-A  
G6ZU-1F-A

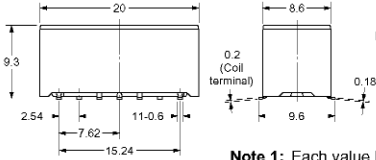
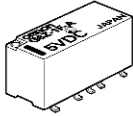

**Note 1:** Each value has a tolerance of  $\pm 0.3$  mm.  
**Note 2:** The coplanarity of the terminals is 0.1 mm max.

**Mounting Dimensions (Top View)**

Tolerance:  $\pm 0.1$  mm

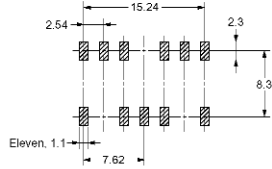

**Terminal Arrangement/Internal Connections (Top View)**

Tolerance:  $\pm 0.1$  mm

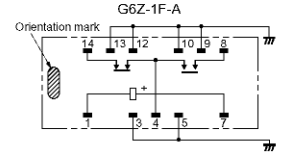

G6ZK-1FE

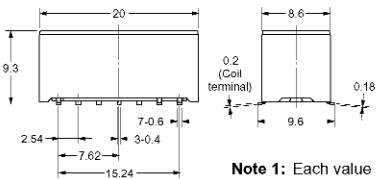
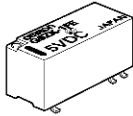

**Note 1:** Each value has a tolerance of  $\pm 0.3$  mm.  
**Note 2:** The coplanarity of the terminals is 0.1 mm max.

**Mounting Dimensions (Top View)**

Tolerance:  $\pm 0.1$  mm

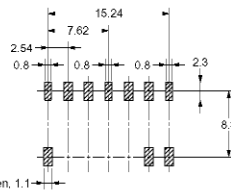

**Terminal Arrangement/Internal Connections (Top View)**

Tolerance:  $\pm 0.1$  mm

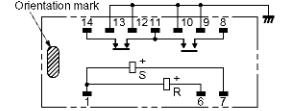

G6ZK-1FE-A

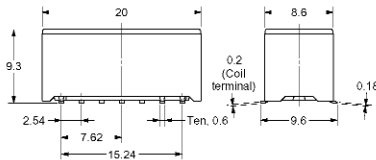
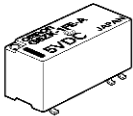

**Note 1:** Each value has a tolerance of  $\pm 0.3$  mm.  
**Note 2:** The coplanarity of the terminals is 0.1 mm max.

**Mounting Dimensions (Top View)**

Tolerance:  $\pm 0.1$  mm

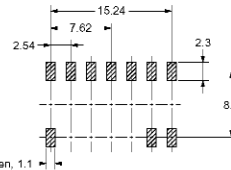

**Terminal Arrangement/Internal Connections (Top View)**

Tolerance:  $\pm 0.1$  mm

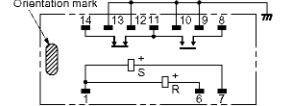

# Surface-Mounting High-Frequency Relay – G6Z

## G6ZK-1F

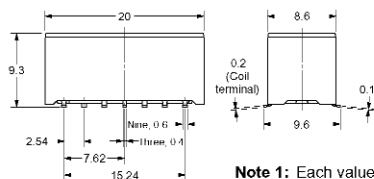
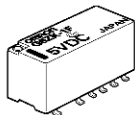

**Mounting Dimensions (Top View)**  
Tolerance:  $\pm 0.1$  mm

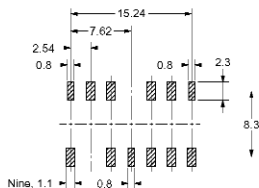

**Terminal Arrangement/Internal Connections (Top View)**

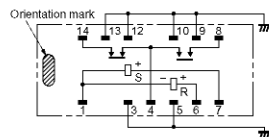

**Note 1:** Each value has a tolerance of  $\pm 0.3$  mm.  
**Note 2:** The coplanarity of the terminals is 0.1 mm max.

## G6ZK-1F-A

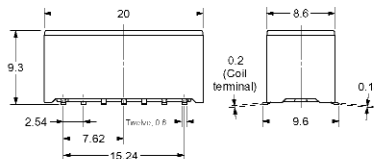
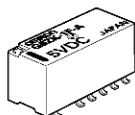

**Mounting Dimensions (Top View)**  
Tolerance:  $\pm 0.1$  mm

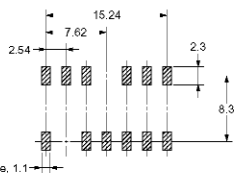

**Terminal Arrangement/Internal Connections (Top View)**

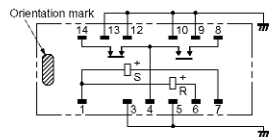

**Note 1:** Each value has a tolerance of  $\pm 0.3$  mm.  
**Note 2:** The coplanarity of the terminals is 0.1 mm max.

## Stick Packing and Tape Packing

### Stick Packing

Relays in stick packing are arranged so that the orientation mark of each Relay is on the left side.

Be sure not to make mistakes in Relay orientation when mounting the Relay to the PCB.

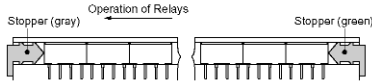

Stick length: 530 mm (stopper not included)  
No. of Relays per stick: 25

### Tape Packing (Surface-mounting Terminal Models)

When ordering Relays in tape packing, add the prefix "TR" to the model number, otherwise the Relays in stick packing will be provided.

Relays per Reel: 300

#### Direction of Relay Insertion

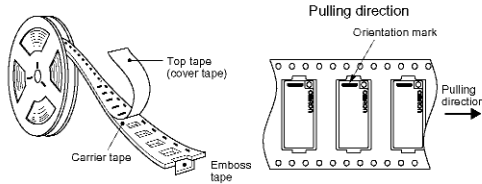

### Reel Dimensions

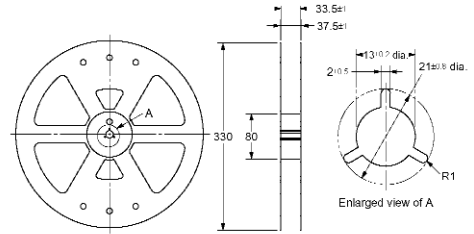

### Carrier Tape Dimensions

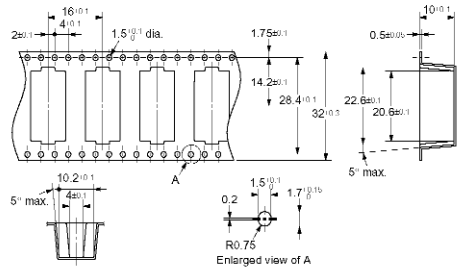

**Note:** The radius of the unmarked corner is 0.3 mm.

## Recommended Soldering Method

### Temperature Conditions for IRS Method

When using reflow soldering, ensure that the Relay terminals and the top of the case stay below the following curve. Check that these conditions are actually satisfied before soldering the terminals.

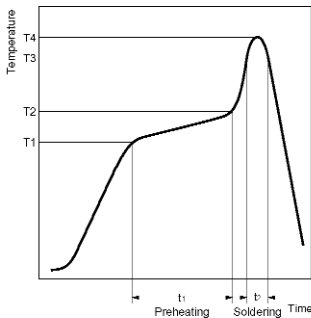

Do not quench the terminals after mounting. Clean the Relay using alcohol or water no hotter than 40°C max.

The thickness of cream solder to be applied should be between 150 and 200 μm on OMRON's recommended PCB pattern.

#### Correct Soldering

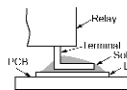

#### Incorrect Soldering

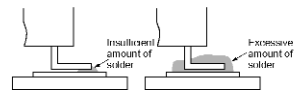

Check the soldering in the actual mounting conditions before use.

Measured part	Preheating (T1 > T2, t1)	Soldering (T3, t2)	Maximum peak (T4)
Terminals	150 → 180°C, 120 s max.	230°C min, 30 s max.	250°C max.
Top of case	---	---	255°C max.

## Safety Precautions

### ■ Precautions for Correct Use

Please observe the following precautions to prevent failure to operate, malfunction, or undesirable effect on product performance.

### High-frequency Characteristics Measurement Method and Measurement Substrate

High-frequency characteristics for the G6Z are measured in the way shown below. Consult your OMRON representative for details on 50-Ω models.

#### Measurement Method for 75-Ω Models

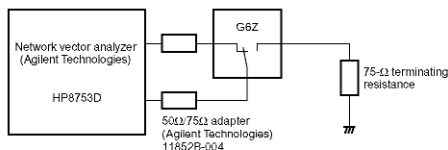

#### Through-hole Substrate (75-Ω Models, E-shape or Y-shape)

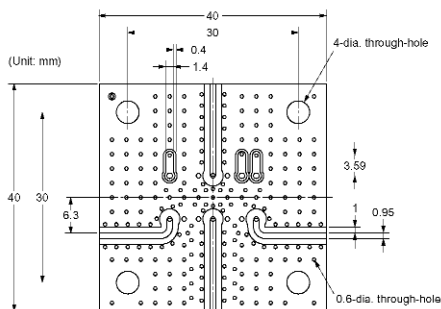

#### SMD-type Substrate (75-Ω Models, E-shape or Y-shape)

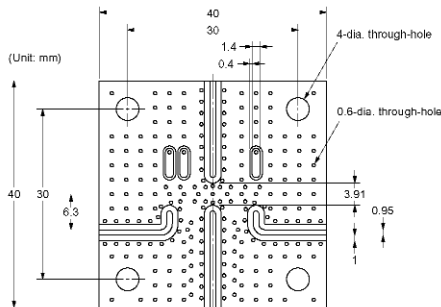

#### Substrate for High-frequency Characteristic Compensation (75-Ω Models, E-shape or Y-shape)

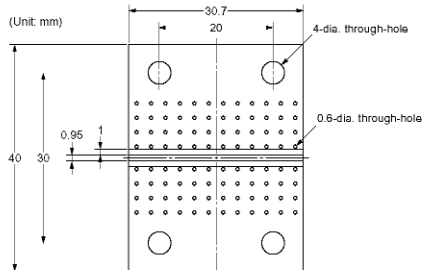

#### Substrate Types

Material: FR-4 glass epoxy (glass cloth impregnated with epoxy resin and copper laminated to its outer surface)

Thickness: 1.6 mm

Thickness of copper plating: 18 μm

- Note:**
1. The compensation substrate is used when measuring the Relay's insertion loss. The insertion loss is obtained by subtracting the measured value for the compensation substrate from the measured value with the Relay mounted to the high-frequency measurement substrate.
  2. For convenience, the diagrams of the high-frequency measurement substrates given here apply both to models with an E-shape terminal structure and to models with a Y-shape terminal structure.
  3. Be sure to mount a standoff tightly to the through-hole substrate.
  4. Use measuring devices, connectors, and substrates that are appropriate for 50 Ω and 75 Ω respectively.
  5. Ensure that there is no pattern under the Relay. Otherwise, the impedance may be adversely affected and the Relay may not be able to attain its full characteristics.

#### Handling

Do not use the Relay if it has been dropped. Dropping the Relay may adversely affect its functionality.

Protect the Relay from direct sunlight and keep the Relay under normal temperature, humidity, and pressure.

#### Flow Soldering

Solder: JIS Z3282, H63A

Soldering temperature: Approx. 250°C (260°C if the DWS method is used)

Soldering time: Approx. 5 s max. (approx. 2 s for the first time and approx. 3 s for the second time if the DWS method is used)

Be sure to make a molten solder level adjustment so that the solder will not overflow on the PCB.

## Claw Securing Force During Automatic Mounting

During automatic insertion of Relays, be sure to set the securing force of each claw to the following so that the Relay's characteristics will be maintained.

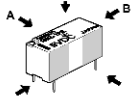

Direction A: 4.90 N max.  
Direction B: 4.90 N max.  
Direction C: 4.90 N max.

Secure the claws to the shaded area.  
Do not attach them to the center area  
or to only part of the Relay.

## Latching Relay Mounting

Make sure that the vibration or shock that is generated from other devices, such as Relays, on the same panel or substrate and imposed on the Latching Relay does not exceed the rated value, otherwise the set/reset status of the Latching Relay may be changed. The Latching Relay is reset before shipping. If excessive vibration or shock is imposed, however, the Latching Relay may be set accidentally. Be sure to apply a reset signal before use.

## Coating

Do not use silicone coating to coat the Relay when it is mounted to the PCB. Do not wash the PCB after the Relay is mounted using detergent containing silicone. Otherwise, the detergent may remain on the surface of the Relay.